

Vee Interests

Plastic and Non-Metallic Solutions

Houston, Texas

Products and Services Catalog 2023



Lined Piping Products

A diverse line of products designed with end users and contractors in mind. These products will help to integrate your next lined piping project.

- Spacers
- Armored Spacers
- Vent Plugs
- Paddle Blinds
- Spectacle Blinds
- Compensation Rings
- Tee/Wye Strainers
- Instrument Fittings
- Injection
- Acid Quills
- Reducing Flanges

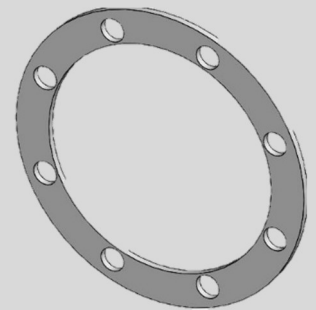

Standard sizes 1"-24"

Custom Orders upon Request

Column Components

Column Components are designed from the ground up. Built to withstand severe service, our non-metallic alternatives will reduce maintenance and increase overall column performance.

- Spargers
- Bed Limiters
- Liquid Distributors
- Packing Support Trays
- Coalescers
- Mist Eliminators
- Packing



Tank Components

Our Line of standardized tank components make for easy modifications to new and existing tanks

- Bulkhead Fittings
- Filtration Laterals
- Vacuum Breakers



Solid Piping Systems

- Blind Flanges
- Instrument Fittings
- Split Ring Flanges
- Custom Fittings
- Threaded Nipples
- Static Mixers
- Calibration Columns
- Basket Strainers
- Sight Glasses
- Plugs
- Injection Tees

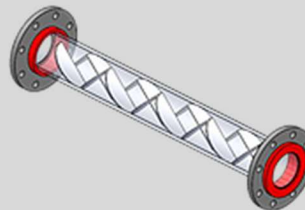
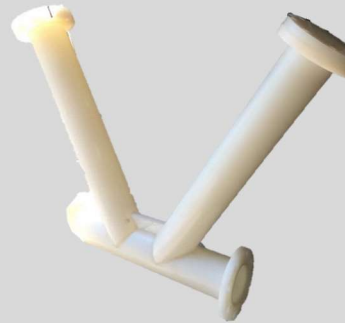
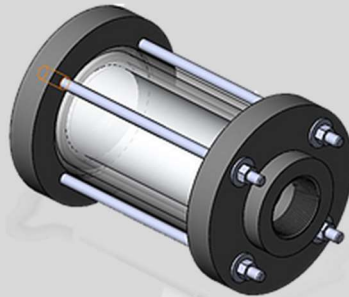
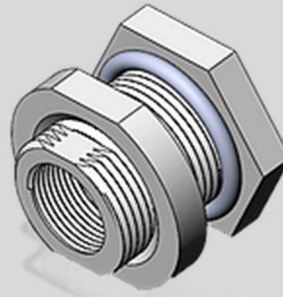
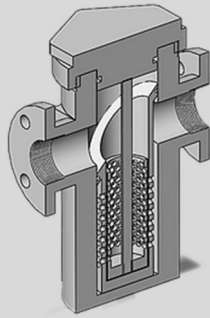

Tank & Column Fabrication

Non-metallic tanks and columns can be designed to fit an existing footprint. Design, analysis, fabrication, & quality control all done in house to provide a fully streamlined process



Custom Machine & Fab

OEM machine parts. Quantities up to 10000 or as few as just 1. Finally replace that part you have never been able to find.



Turnkey Systems

Turnkey systems are designed and fabricated in house to meet customers unique needs. Join in on the design process for a turnkey solution when off the shelf products aren't suitable. These made to order packages can be designed to run autonomously.

- Scrubbers
- Strippers
- Acidulation Columns
- Water Treatment
- Chemical Injection
- Chemical Dilution

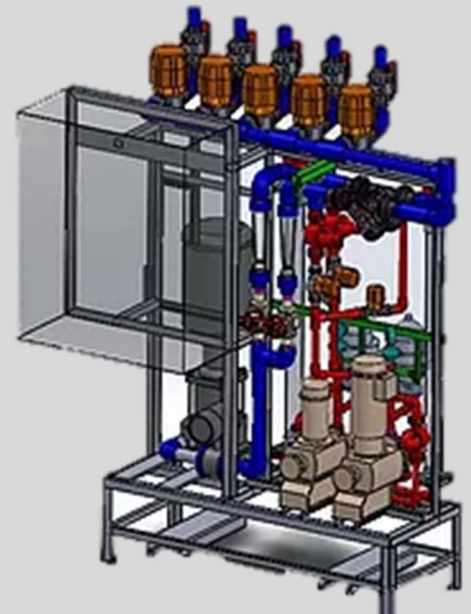
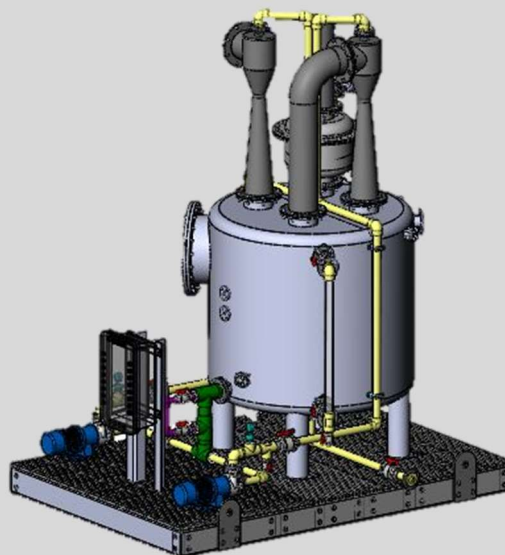
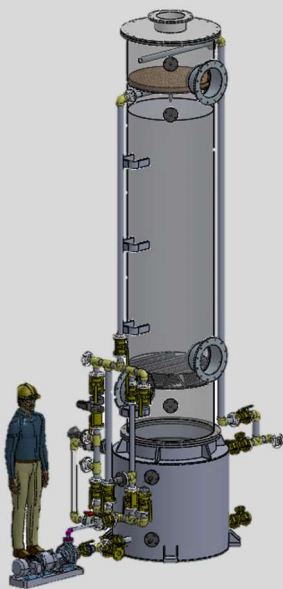
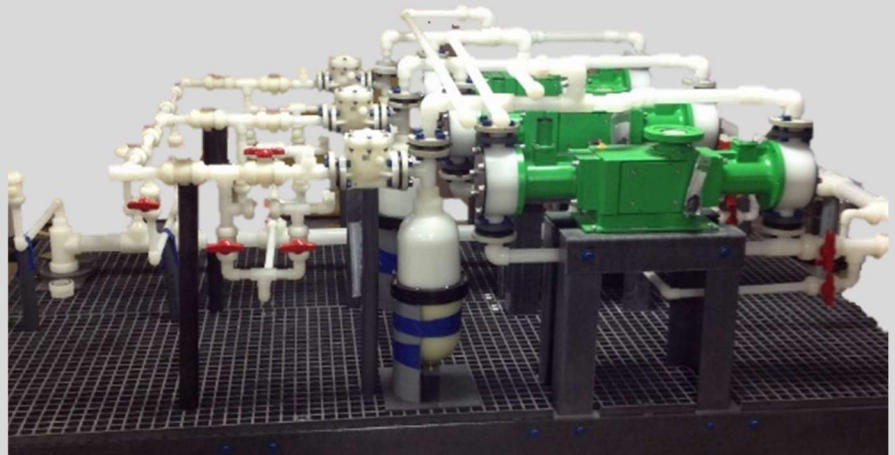

Pipe Fabrication

We offer pipe fabrication of all common engineering thermoplastics. With over 50 years of experience in plastic welding on staff, we can create a completely corrosion resistant product for just about any area of industry. Our ANSI B31.3 certified team can also produce spool drawings for your project.

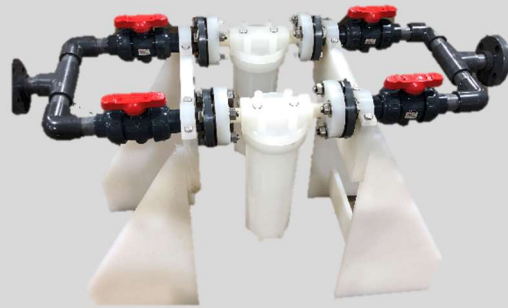

Vee Interests, LLC

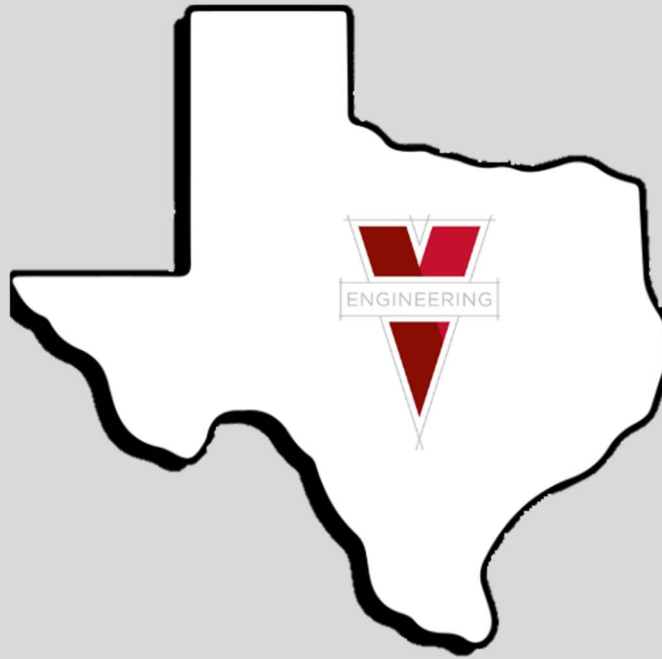

**1911 Jasmine Dr
Pasadena, TX 77503
(832) 864-2001**

Paul Vaughn — paul@veeinterests.com

Joe Vaughn — joe@veeinterests.com

www.VeeInterests.com